







7.1.1.1 ALIBABA



-  6+
-  1 user
-  2.5 x 1 x 1.2 m
-  5.5 x 4 m
-  0.4 m
-  22 m²
-  ca 250 kg

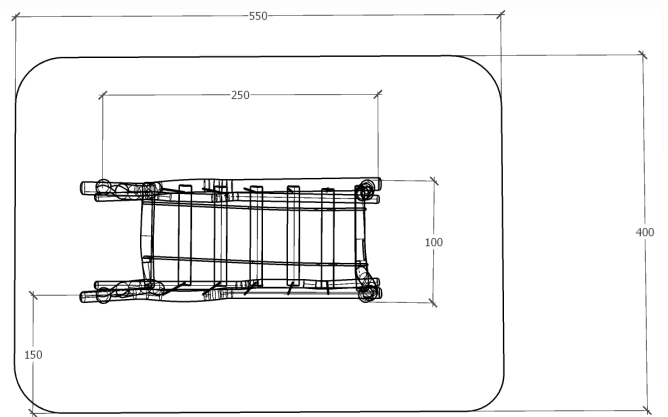

i Components:

- Wood-chain bridge

