







PLAY HOUSES

# 4.2.2 MULAN + TERRACE



-  0+
-  6 users
-  1.2 x 2.2 x 1.9 m
-  4.2 x 5.2 m
-  <0.6 m
-  -
-  ca. 300 kg

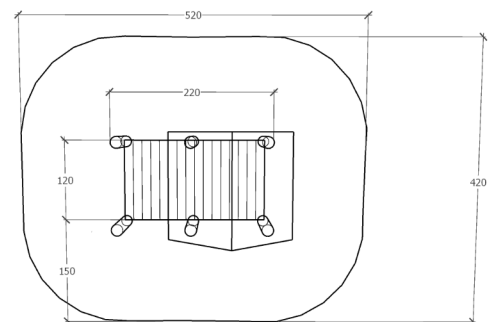

**i** Components:

- Wooden house
- Terrace
- 2 pots
- Woodcarved flower 2D

