

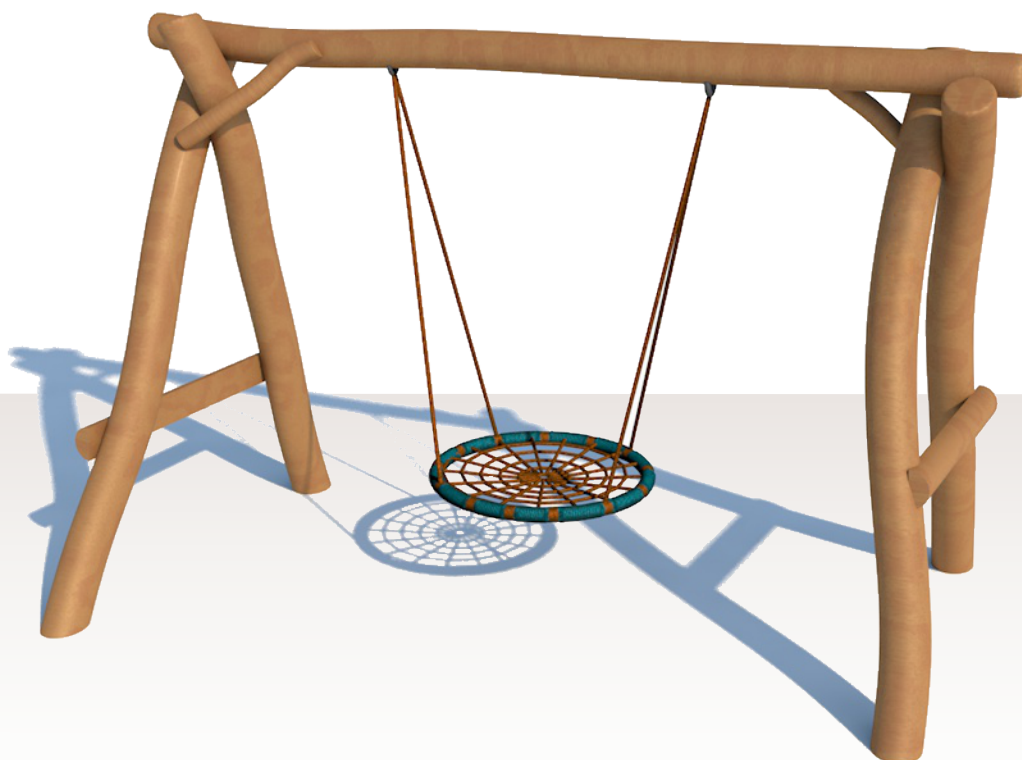







## SWINGS

# 2.1.5 RHYTHM



-  3+
-  2 users
-  3.35 x 2 x 2.6
-  6.35 x 7.3 m
-  1.2 m
-  26 m<sup>2</sup>
-  ca. 200 kg

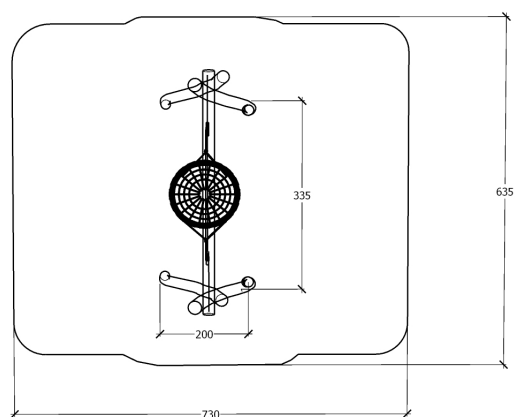

### Components:

- Stainless steel hinges
- Galvanized chains
- Nest swing, diameter 100 cm

