







# 1.3.6 SPIDERMAN



-  3+
-  24 users
-  6.5 x 7 x 3.2 m
-  9.5 x 10 m
-  1 m
-  75 m<sup>2</sup>
-  ca. 1900 kg

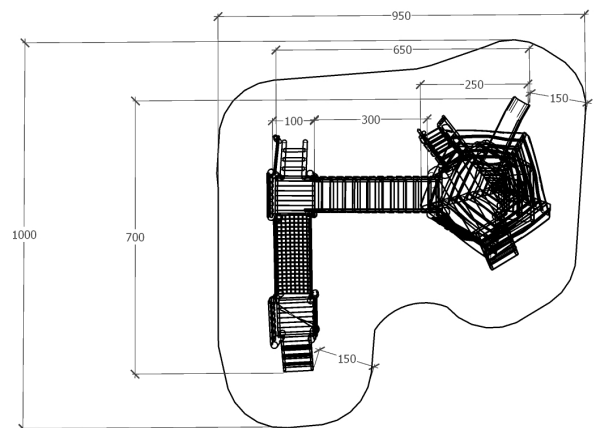

## Components:

- Tower
- Stairs
- 2 entering platform
- Ladder
- Climbing net
- Climbing wall
- Rope bridge
- Spiderman and net painting
- Solid wooden bridge
- Wooden flag with custom text
- Laminate slide h. 1 m

*(can be upon request replaced by a stainless steel slide (additional fee))*

